

Objet

Principe d'introduction au sous-sol

Sous-station SYSBO X20-S10 / 5-50kW

Date	Auteur	Visa	Archivage
22.03.2022	OLR	ACO	U:\19_Support_EXP\01_Plans\01_Originaux\01_CAD\02_Plans-types\Introductions\Plans-dwg\Intro-CAD-ss_SYSBO-LYS.dwg



Lys Energie SA
Route du Vieux-Canal 6
1762 Givisiez

DETAIL

Les cotes et dimensions seront à définir lors de l'élaboration du projet avec le prestataire en charge de l'installation secondaire.

Forages pour intro

(cotes en mm)

Tuyaux CAD		Joint Labyrinthe		Joint Doyma	
DN	Ø ext tuyau	Ø Carottage	entre axe min	Ø Carottage	entre axe min
20	110	250	260	200	280
25	110	250	260	200	280
32	125	300	275	200	280
40	125	300	275	200	280
50	140	300	290	200	290
65	160	300	310	250	330
80	180	350	330	250	330
100	225	400	425	300	425
125	250	400	450	350	450
150	280	450	480	350	480
200	355	500	555	450	555

Tuyau électrique PE 60/72mm = carottage Ø125mm

ELEVATION

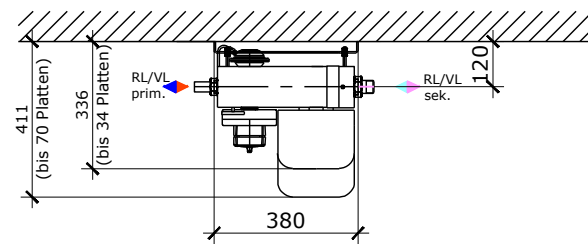

Rez-de-chaussée

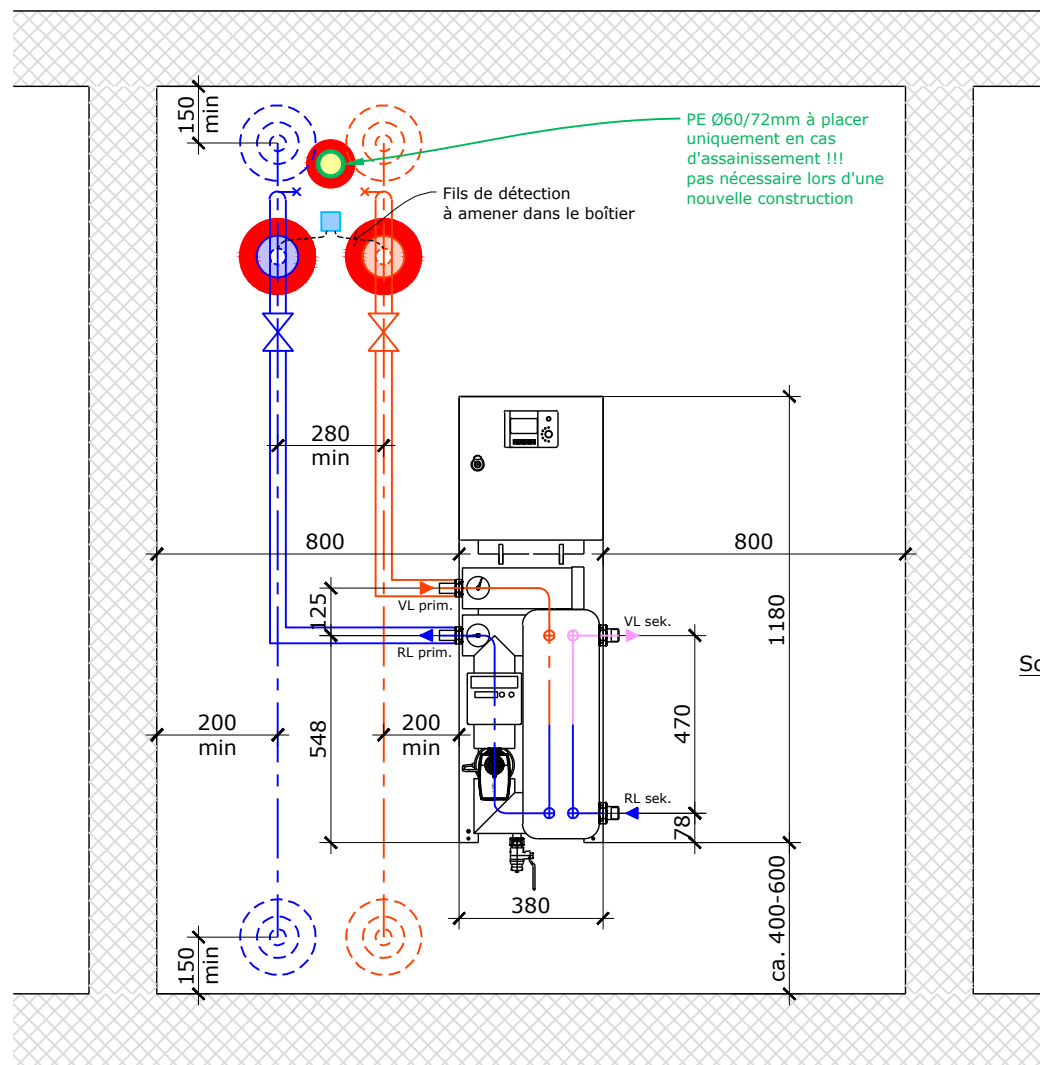

Sous-sol

COUPE JOINT DOYMA

Murs en béton

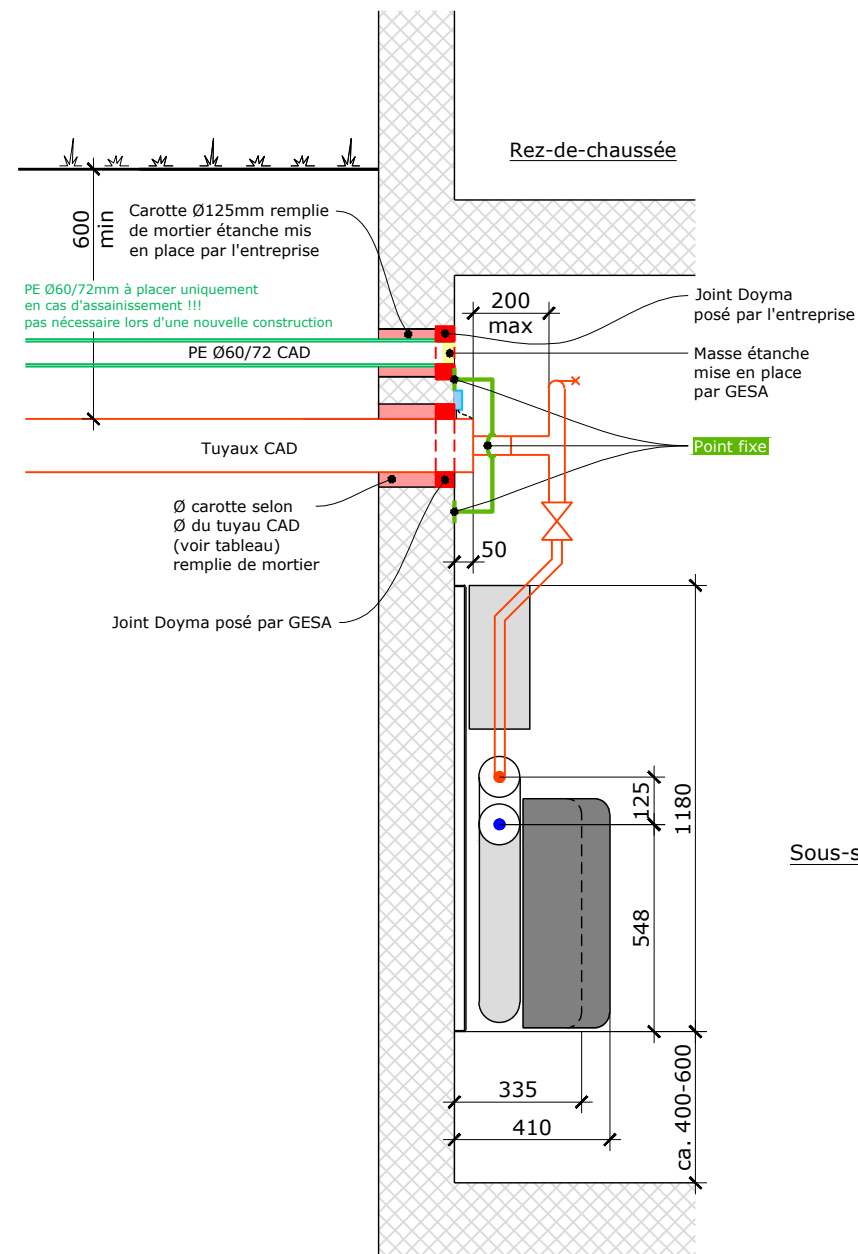

COUPE JOINT LABYRINTHE

Murs en briques ou moellons

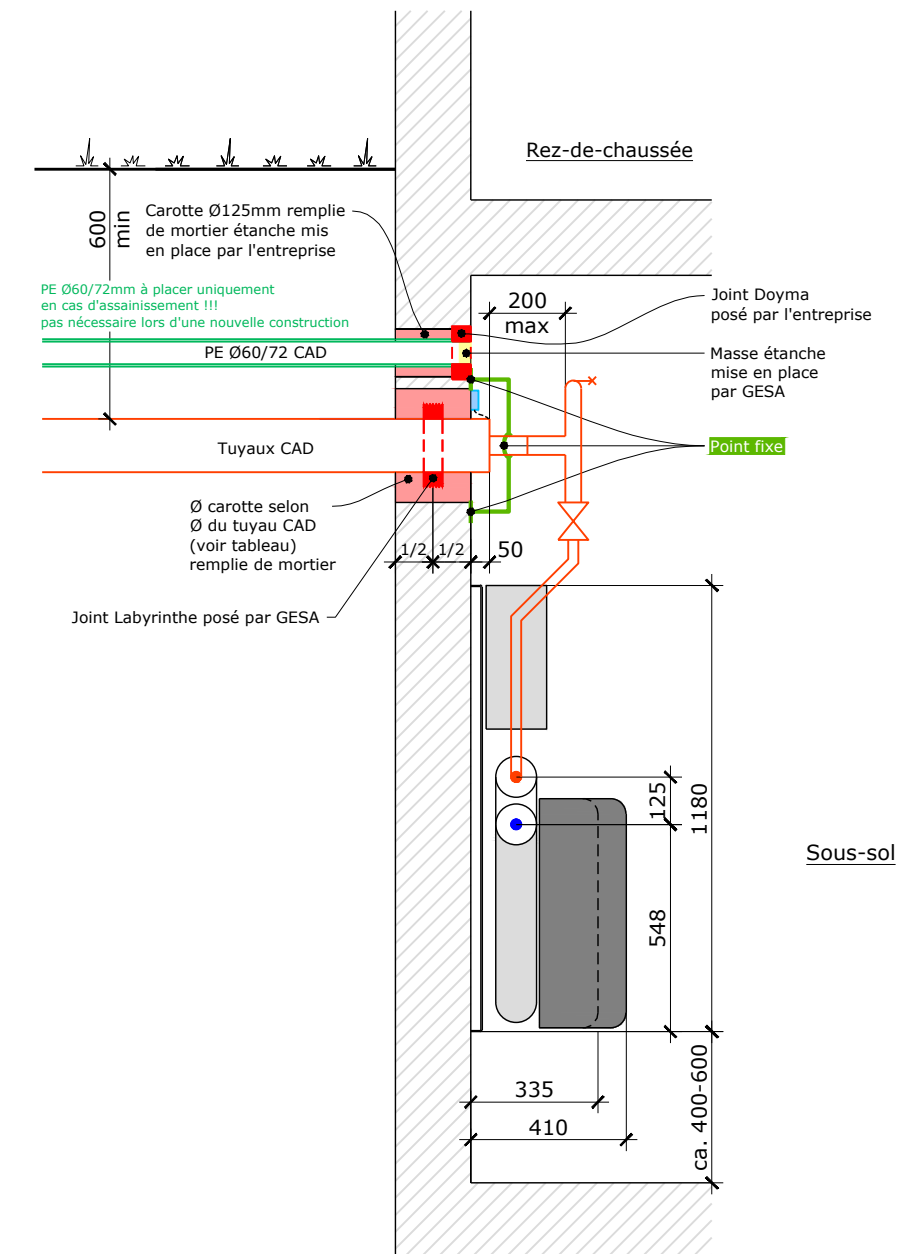

Objet

Principe d'introduction au sous-sol

Sous-station SYSBO X20-S20 / 50-90kW

Date	Auteur	Visa	Archivage
22.03.2022	OLR	ACO	U:\19_Support_EXP\01_Plans\01_Originaux\01_CAD\02_Plans-types\Introductions\Plans-dwg\Intro-CAD-ss_SYSBO-LYS.dwg



Lys Energie SA
Route du Vieux-Canal 6
1762 Givisiez

DETAIL

Les cotes et dimensions seront à définir lors de l'élaboration du projet avec le prestataire en charge de l'installation secondaire.

Forages pour intro

(cotes en mm)

DN	Tuyaux CAD		Joint Labyrinthe		Joint Doyma	
	Ø ext tuyau	Ø Carottage	entre axe min	Ø Carottage	entre axe min	
20	110	250	260	200	280	
25	110	250	260	200	280	
32	125	300	275	200	280	
40	125	300	275	200	280	
50	140	300	290	200	290	
65	160	300	310	250	330	
80	180	350	330	250	330	
100	225	400	425	300	425	
125	250	400	450	350	450	
150	280	450	480	350	480	
200	355	500	555	450	555	

Tuyau électrique PE 60/72mm = carottage Ø125mm

ELEVATION

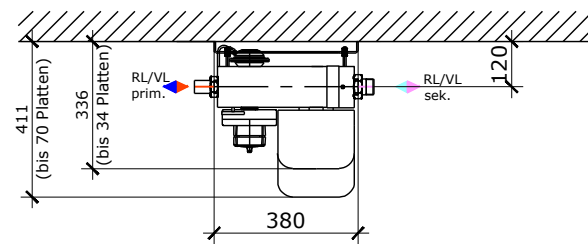

Rez-de-chaussée

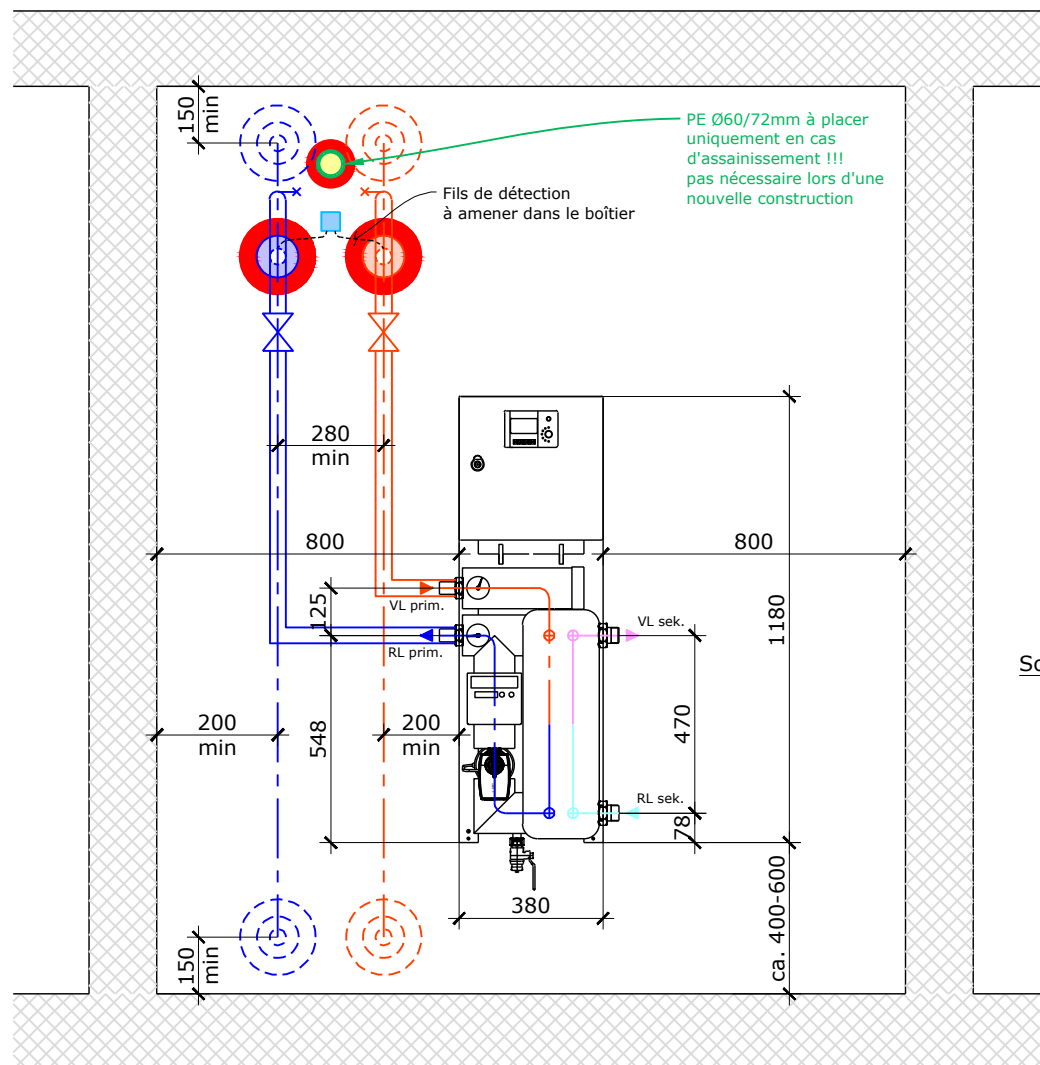

Sous-sol

COUPE JOINT DOYMA

Murs en béton

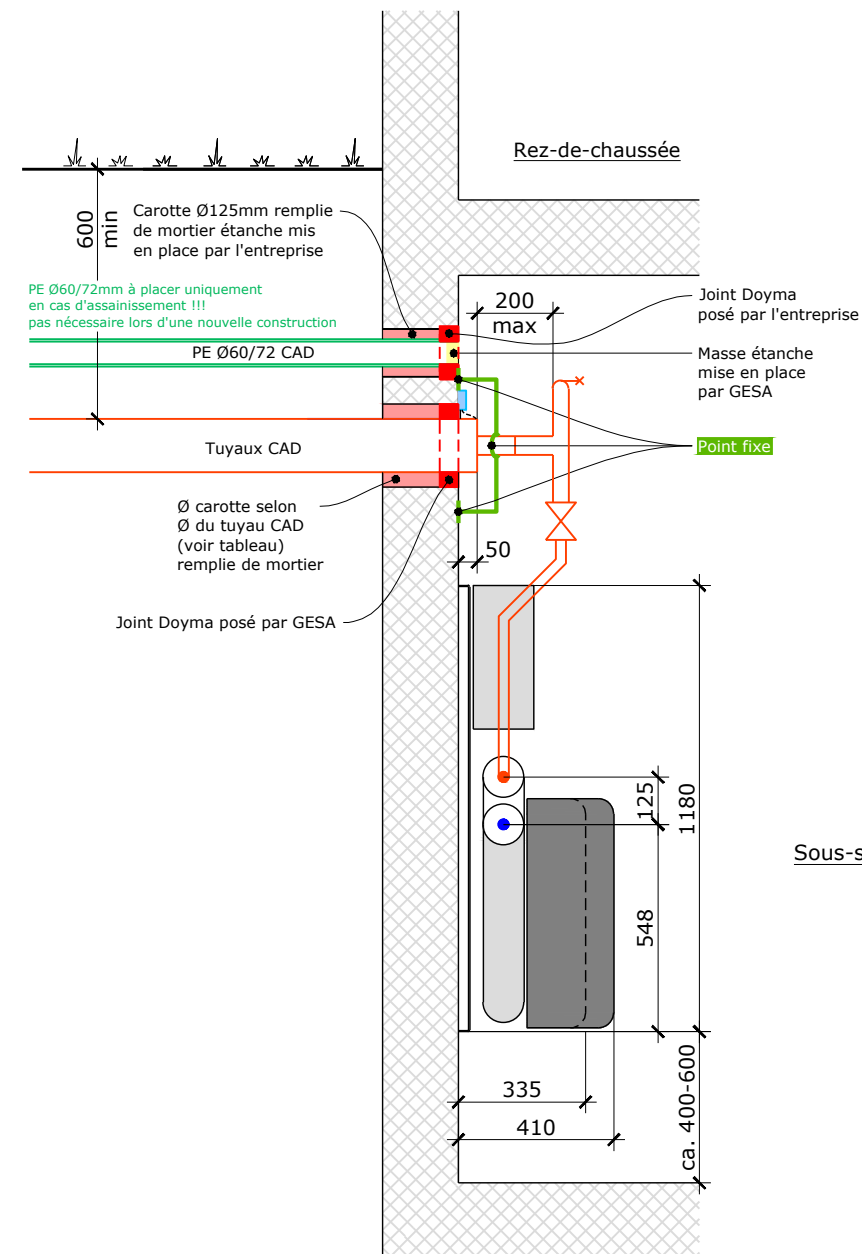

COUPE JOINT LABYRINTHE

Murs en briques ou moellons

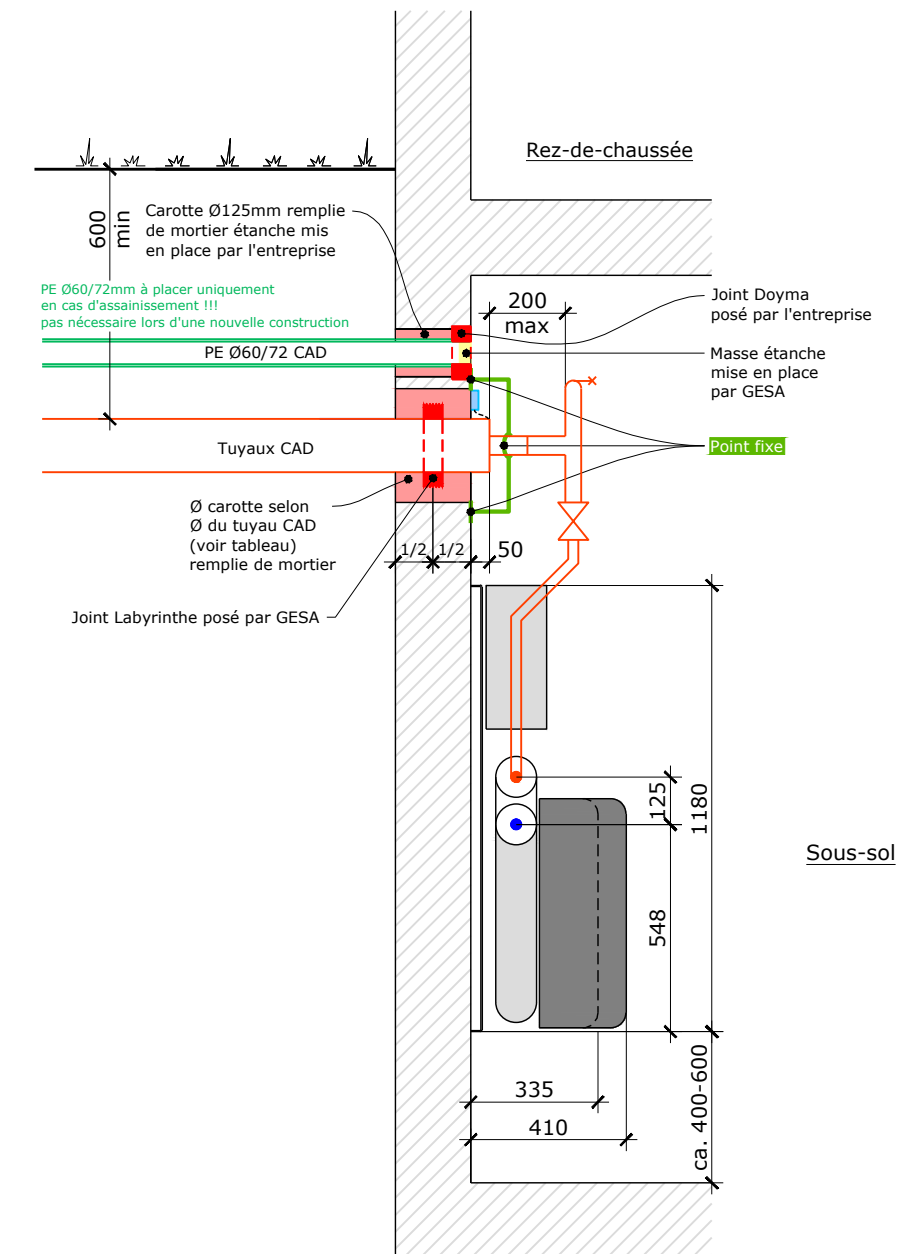

Objet

Principe d'introduction au sous-sol

Sous-station SYSBO X20-M10 / 90-150kW

Date	Auteur	Visa	Archivage
22.03.2022	OLR	ACO	U:\19_Support_EXP\01_Plans\01_Originaux\01_CAD\02_Plans-types\Introductions\Plans-dwg\Intro-CAD-ss_SYSBO-LYS.dwg



Lys Energie SA
Route du Vieux-Canal 6
1762 Givisiez

DETAIL

Les cotes et dimensions seront à définir lors de l'élaboration du projet avec le prestataire en charge de l'installation secondaire.

Forages pour intro

(cotes en mm)

Tuyaux CAD		Joint Labyrinthe		Joint Doyma	
DN	Ø ext tuyau	Ø Carottage	entre axe min	Ø Carottage	entre axe min
20	110	250	260	200	280
25	110	250	260	200	280
32	125	300	275	200	280
40	125	300	275	200	280
50	140	300	290	200	290
65	160	300	310	250	330
80	180	350	330	250	330
100	225	400	425	300	425
125	250	400	450	350	450
150	280	450	480	350	480
200	355	500	555	450	555

Tuyau électrique PE 60/72mm = carottage Ø125mm

ELEVATION

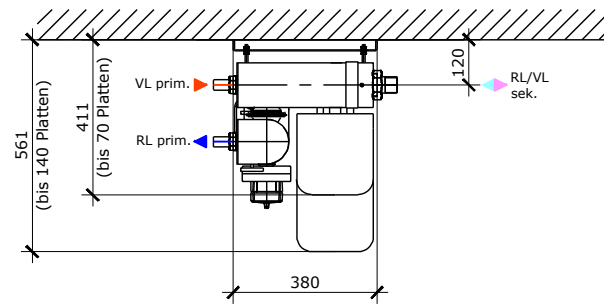

Rez-de-chaussée

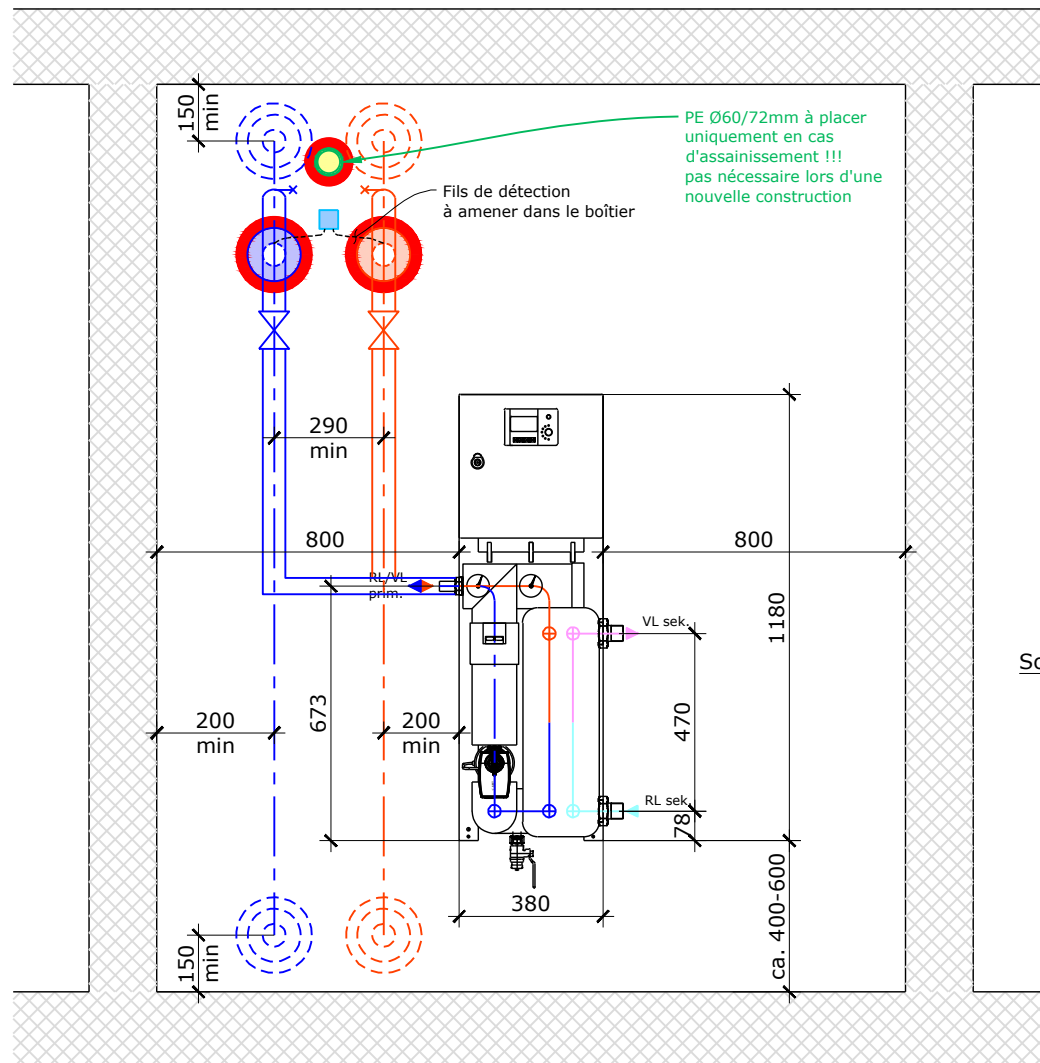

Sous-sol

COUPE JOINT DOYMA

Murs en béton

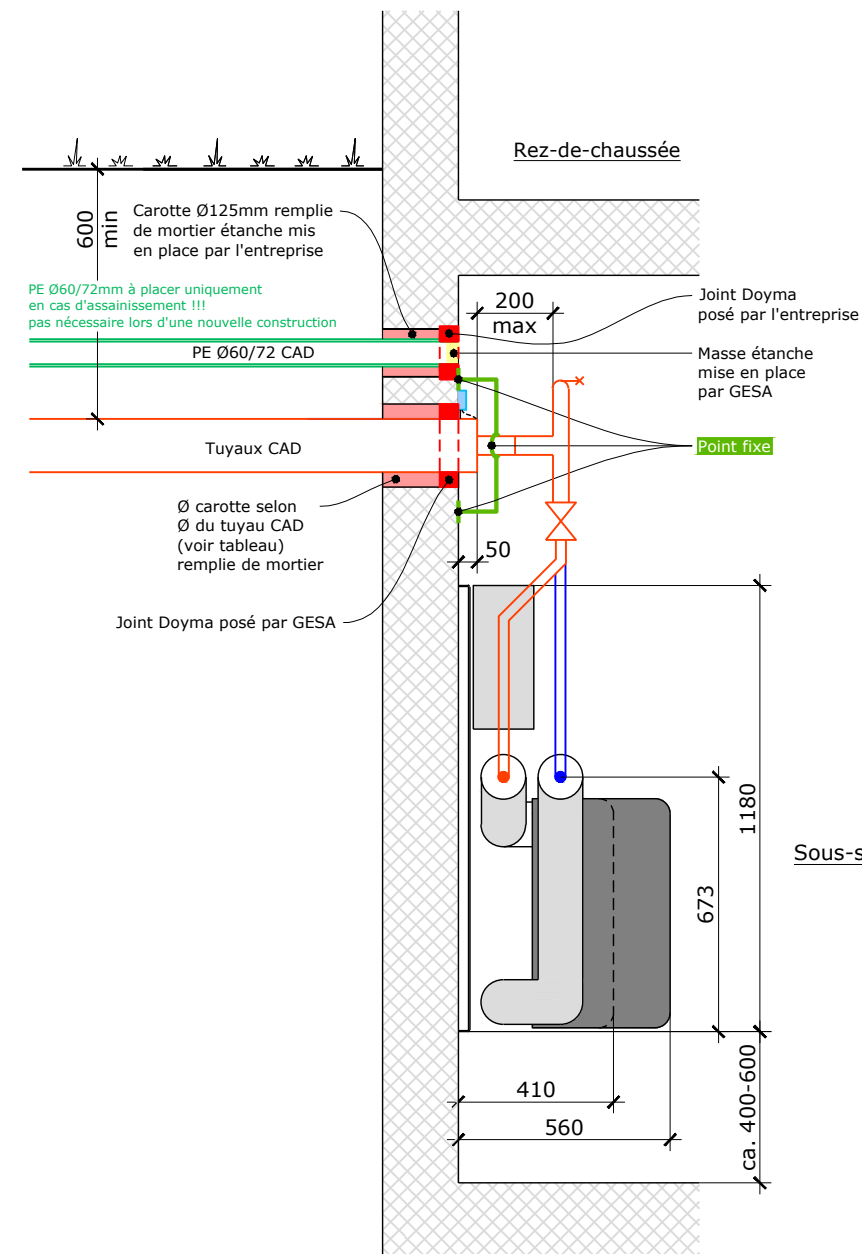

Sous-sol

COUPE JOINT LABYRINTHE

Murs en briques ou moellons

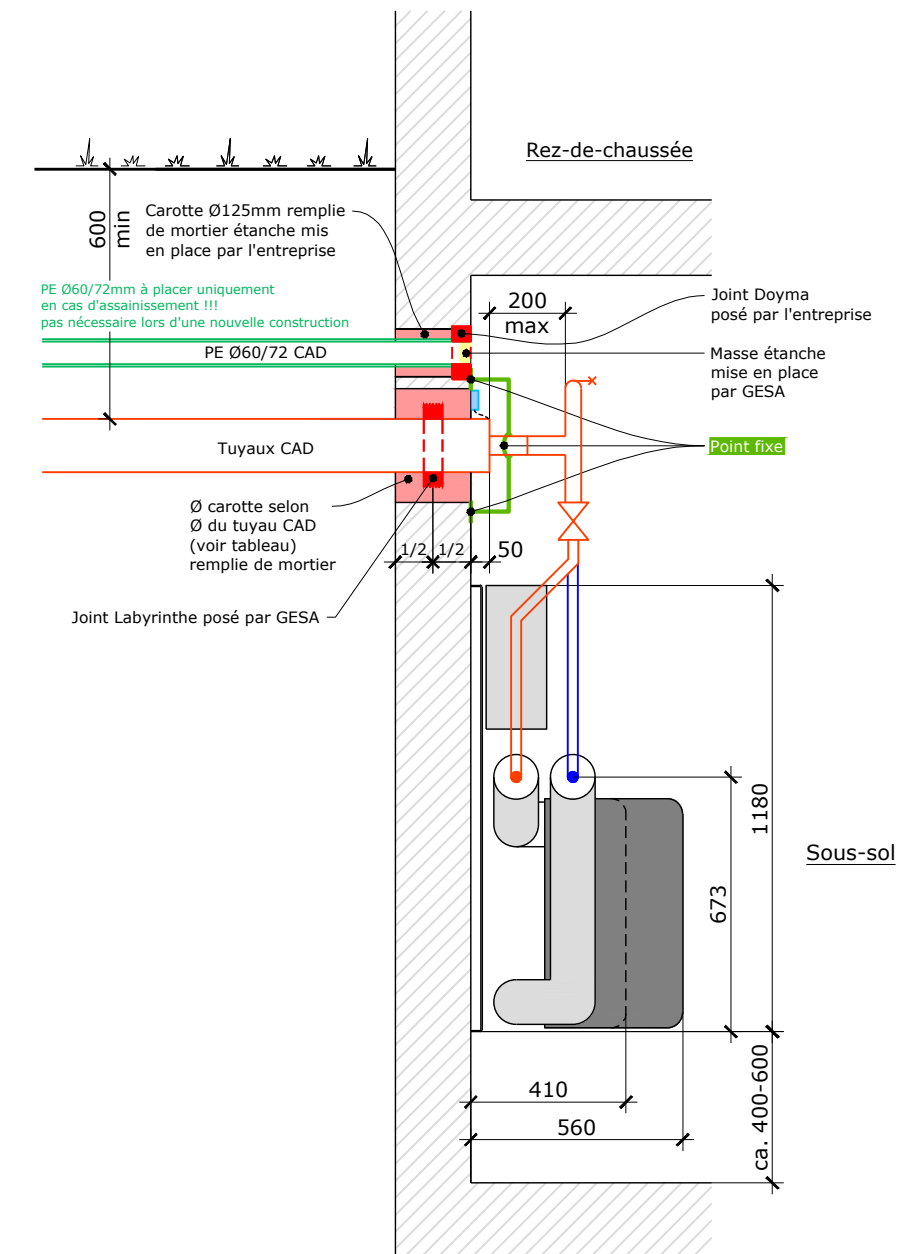

Sous-sol

Objet

Principe d'introduction au sous-sol

Sous-station SYSBO X20-L20 / 150-350kW

Date	Auteur	Visa	Archivage
22.03.2022	OLR	ACO	U:\19_Support_EXP\01_Plans\01_Originaux\01_CAD\02_Plans-types\Introductions\Plans-dwg\Intro-CAD-ss_SYSBO-LYS.dwg



Lys Energie SA
Route du Vieux-Canal 6
1762 Givisiez

DETAIL

Les cotes et dimensions seront à définir lors de l'élaboration du projet avec le prestataire en charge de l'installation secondaire.

Forages pour intro

(cotes en mm)

DN	Tuyaux CAD		Joint Labyrinthe		Joint Doyma	
	Ø ext tuyau	Ø Carottage	entre axe min	Ø Carottage	entre axe min	
20	110	250	260	200	280	
25	110	250	260	200	280	
32	125	300	275	200	280	
40	125	300	275	200	280	
50	140	300	290	200	290	
65	160	300	310	250	330	
80	180	350	330	250	330	
100	225	400	425	300	425	
125	250	400	450	350	450	
150	280	450	480	350	480	
200	355	500	555	450	555	

Tuyau électrique PE 60/72mm = carottage Ø125mm

ELEVATION

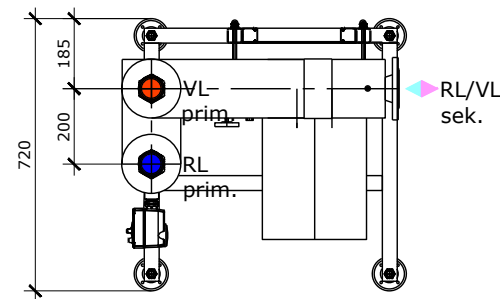

Rez-de-chaussée

COUPE JOINT DOYMA

Murs en béton

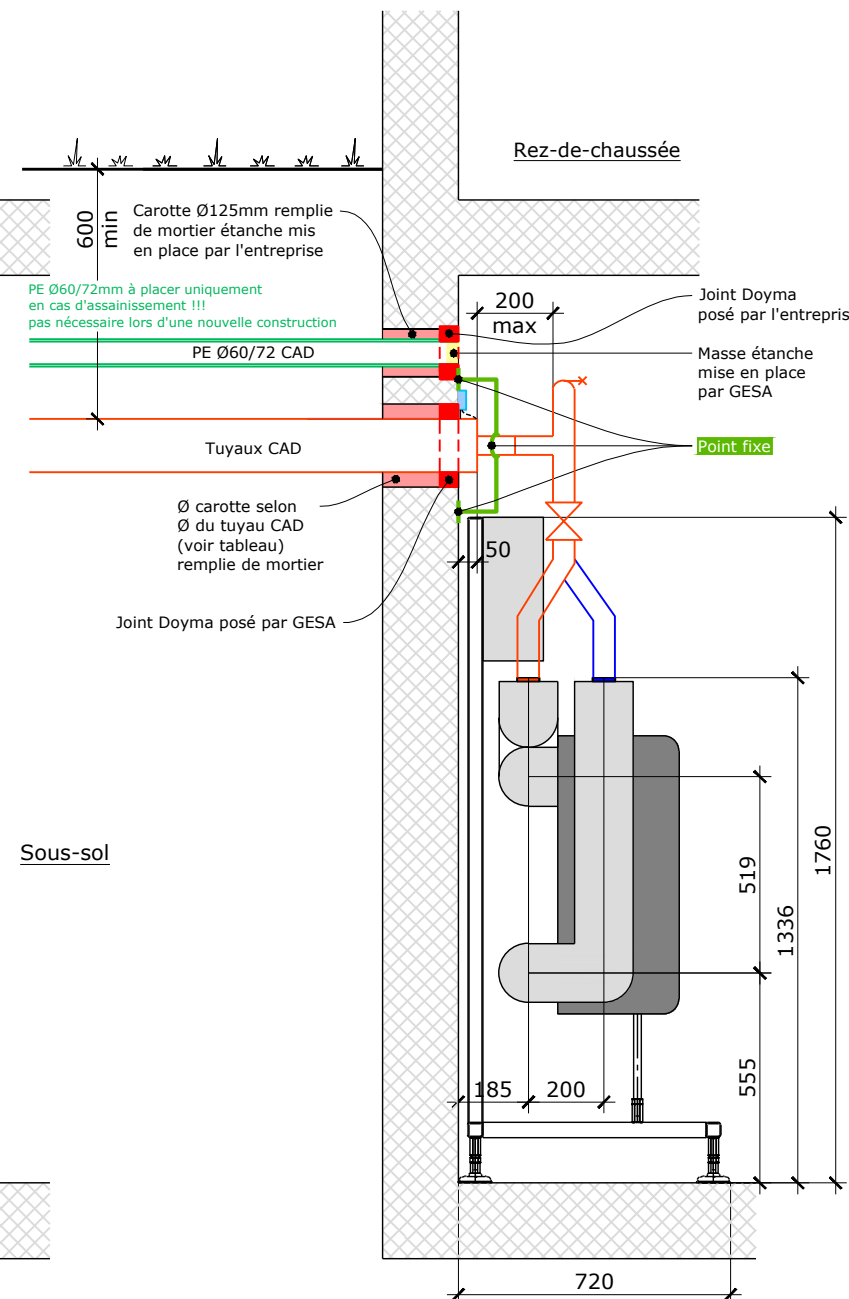

COUPE JOINT LABYRINTHE

Murs en briques ou moellons

